

LOCK BOXES

#1

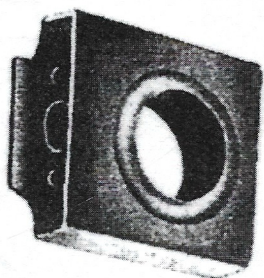

1"

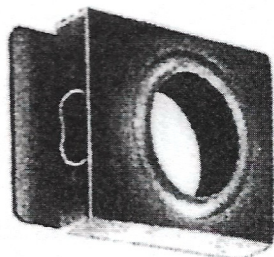

1 1/4"

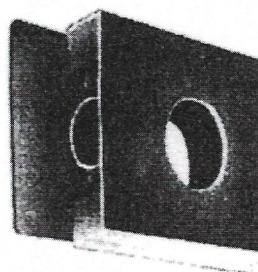

1 1/2"

#2

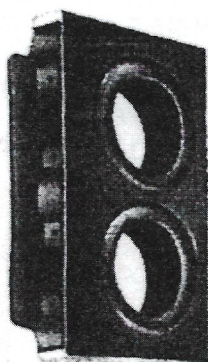

1"

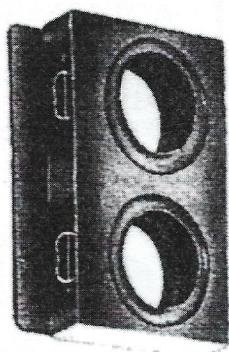

1 1/4"

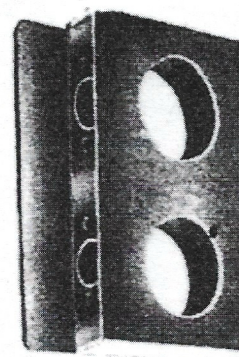

1 1/2"

LOCKS & BOLTS

HOOKBOLT
LOCK

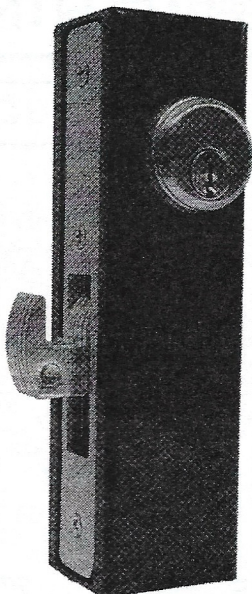

7" HIGH
2" WIDE
1 3/4" THICK

EXTRA HEAVY DUTY SLIDE BOLT

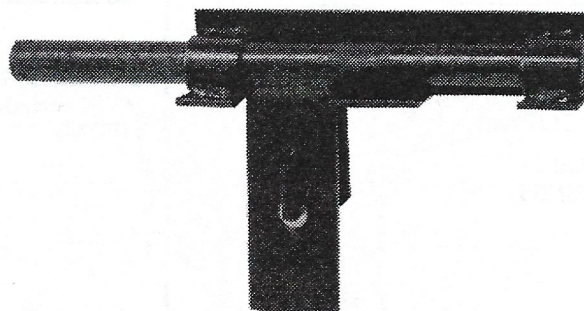

9 1/2" LONG
3/4" BOLT

WINDOW RELEASES

#4

PUSH BUTTON RELEASE

- PUSH BUTTON RELEASE INSIDE
- EASY-QUICK INSTALLATION
- NO ASSEMBLY REQUIRED ON LOCK MECHANISM
- ONLY ONE SMALL 5/16" BORE THROUGH THE WALL
- WEATHER PROOFED
- TAMPER PROOF FOR ADDED RELIABILITY
- BRASS ROD THROUGH WALL

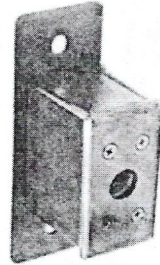

#5

WINDOW GUARD RELEASE

- REQUIRES 1/2" HOLE THROUGH WALL
- SPRING LOADED (SPRING REMAINS IN CYLINDER WALL HEAD WHEN WINDOW GUARD IS OPEN)

7" LONG
9" LONG
11" LONG

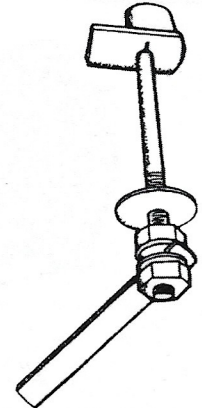

HINGES

DECORATIVE "H" HINGE

- STORM DOOR HINGE
- BLACK HAMMERED FORGED FINISH
- TIGHT PIN

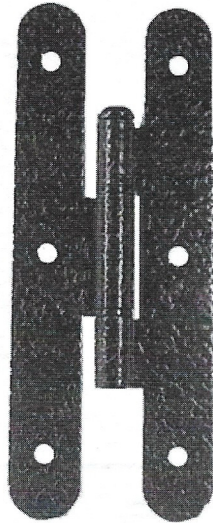

ADJUSTABLE BARREL HINGES

5/8" STEEL J-BOLT
BALL BEARING -
GREASE FITTING

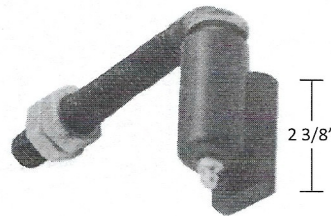

BOLT LENGTH 4 3/8"
1 5/8" CLEARANCE
BETWEEN GATE & POST

3/4" STEEL J-BOLT
BALL BEARING -
GREASE FITTING

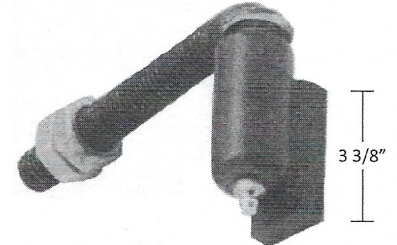

BOLT LENGTH 6 3/4"
2 3/4" CLEARANCE
BETWEEN GATE & POST

HEAVY DUTY WELDABLE HINGES

#6

3/4" WIDE
3/8" STEEL PIN
NO BALL BEARINGS

GOOD FOR
SMALLER GATE



3" BARREL HINGE

#12

BALL BEARING
WITH GREASE
FITTING



5" BARREL HINGE

#12

BALL BEARING
WITH GREASE
FITTING



7" BARREL HINGE

WELDABLE HINGES

#11

NARROW WIDTH
BLANK (NO HOLES)
TIGHT PIN
SWAGED
.098 GAUGE
WELDABLE

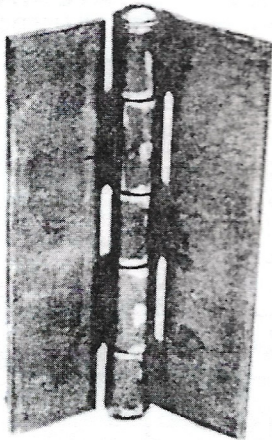

2 1/4" X 3 1/2"
FOR 1" TUBING

BLANK (NO HOLES)
TIGHT PIN
NON SWAGED
.083 GAUGE
WELDABLE

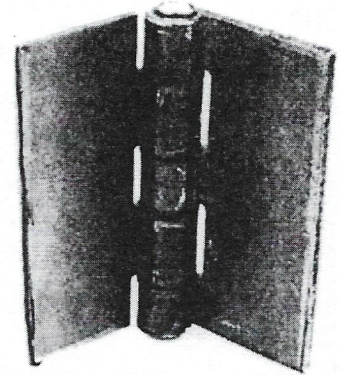

2" X 2"
FOR 3/4" TUBING

BLANK (NO HOLES)
TIGHT PIN
NON SWAGED
.092 GAUGE
WELDABLE

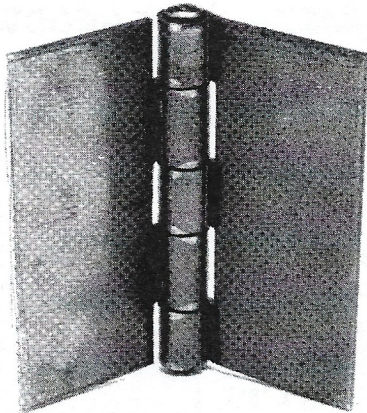

3" X 3"
FOR 1 1/4" TUBING

BLANK (NO HOLES)
TIGHT PIN
SWAGED
.098 GAUGE
WELDABLE

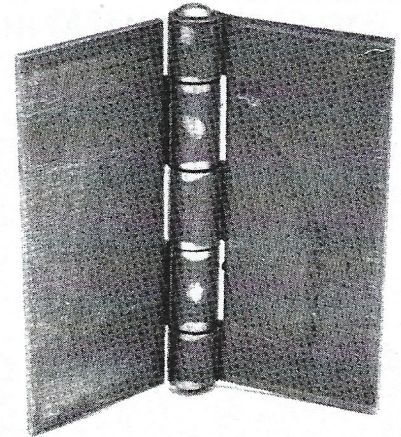

4" X 4"
FOR 1 1/2" TUBING

GATE HARDWARE

#13

HEAVY DUTY SLIDE BOLT

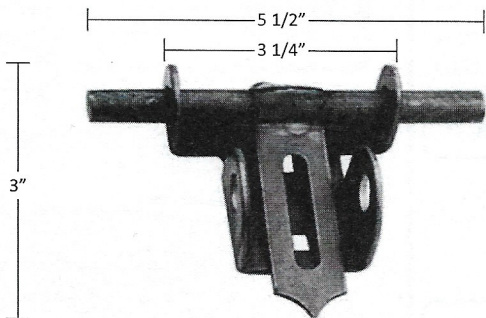

CUPLER (RECEIVER) NOT INCLUDED
WELDABLE STEEL
1/2" BOLT

#16

GRAVITY GATE LATCH

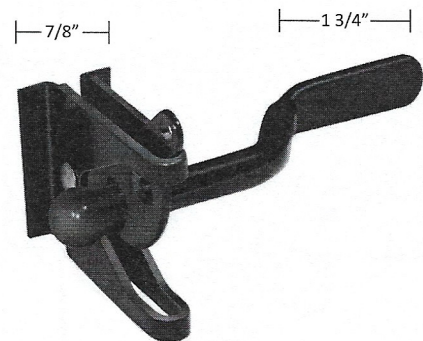

SELF-LATCHING
NO SCREW HOLES

GATE HARDWARE

#3

CADMIUM CANE BOLTS

12"



#3A

18"

#3B

24"

#14

GATE HANGER "J" BOLT

TO BE USED WITH FEMALE BAT WING HINGE

GALVANIZED

STANDARD
DUTY
1/2" X 4 1/2"
(2 NUTS)

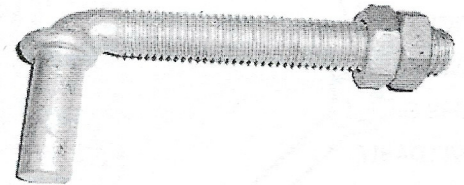

#14A

GALVANIZED

HEAVY DUTY
5/8" X 4 1/2"
(2 NUTS)

#15A

BAT WING HINGES

FEMALE
WELDABLE
FOR 1/2" PIN
OR 5/8" PIN



#15B

FEMALE
WELDABLE
1/2" PIN OR
5/8" PIN



#17

"V" GROOVE WHEELS

3 1/8" HIGH
2" WIDE
1/8" THICK
1" BASE
3/8" HOLE
DIAMETER



#17B

**MOUNTING BOX
FOR GROOVE WHEELS**

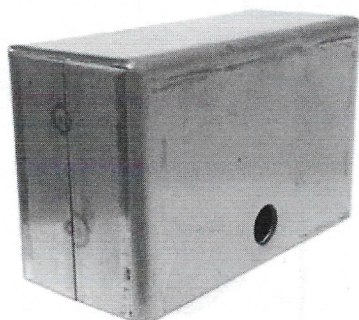

GREAT FOR EASY INSTALLATION
OF GROOVE WHEELS

#18

RUBBER GUIDE ROLLERS

3" HIGH



#18A

6" HIGH



#18B

12" HIGH



WELD TABS & BASE PLATES

#34A

WELD TAB

1 1/2" HIGH
1" WIDE
1/8" THICK
3/8" HOLE
DIAMETER

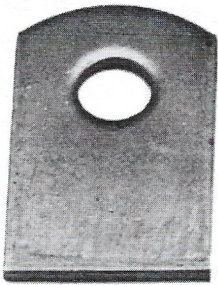

#34B

WELD TAB

2 3/8" HIGH
1" WIDE
1/8" THICK
3/8" HOLE
DIAMETER



#34C

WELD TAB

2 5/8" HIGH
2" WIDE
1/8" THICK
1" BASE
3/8" HOLE
DIAMETER



#34D

WELD TAB

3 1/8" HIGH
2" WIDE
1/8" THICK
1" BASE
3/8" HOLE
DIAMETER

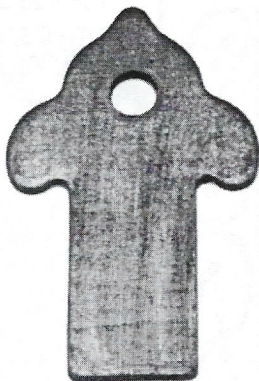

#34E

WELD TAB

2 7/8" HIGH
2 5/8" WIDE
1/8" THICK
1" BASE
3/8" HOLE
DIAMETER
EXTENSION
7/8" X 7/8"

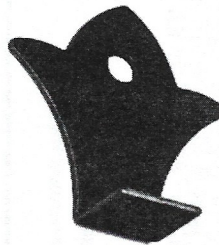

#34F

BASE PLATE

3 1/4" LONG
1" WIDE
3/8" HOLES
3/16" THICK



#34G

BASE PLATE

4 1/4" LONG
1 1/2" WIDE
3/8" HOLES
3/16" THICK



#34H

WELD TAB

"L" BRACKETS
FOR WINDOW
GUARDS AND
RAILINGS

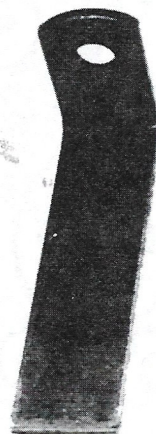

#35

BASE PLATE

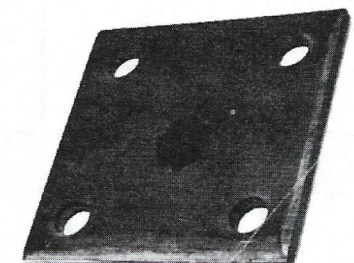

3" X 3"

5" X 5"

4" X 4"

6" X 6"

ALUMINUM PICKET CASTINGS

#7

SINGLE FACED
HEIGHT 16 1/2"
WIDTH 6 3/4"

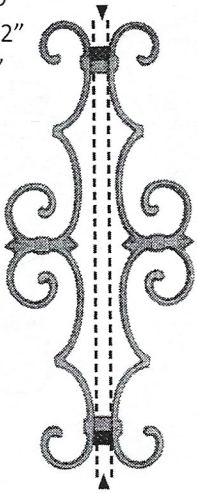

SIZES
1/2"
5/8"
3/4"

#8

SINGLE FACED
HEIGHT 16 1/2"
WIDTH 6 3/4"

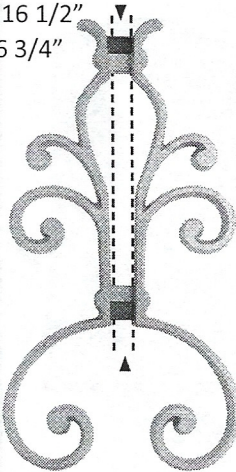

SIZES
1/2"
5/8"
3/4"

#9

SINGLE FACED
HEIGHT 16 1/2"
WIDTH 6 3/4"

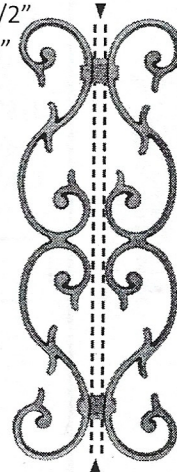

SIZE
1/2"

#10

SINGLE FACED
HEIGHT 16 1/2"
WIDTH 6 3/4"

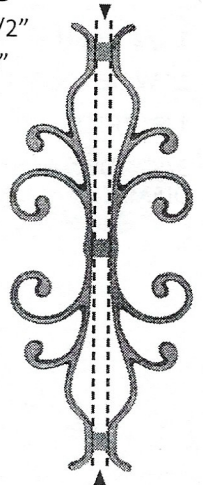

SIZES
1/2"
5/8"
3/4"

#43

SINGLE FACED
HEIGHT 16 1/2"
WIDTH 6 3/4"



SIZE
1/2"

#44

SINGLE FACED
HEIGHT 16 1/2"
WIDTH 6 3/4"

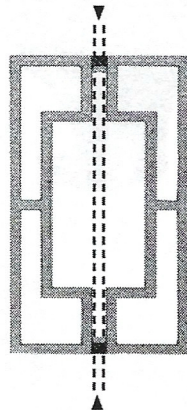

SIZE
1/2"

#45

SINGLE FACED
HEIGHT 16 1/2"
WIDTH 6 3/4"

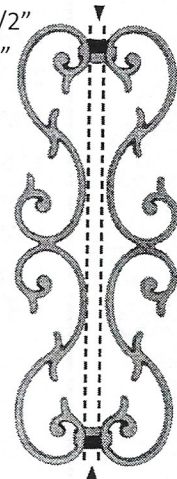

SIZE
1/2"

#46

SINGLE FACED
HEIGHT 16 1/2"
WIDTH 6 3/4"

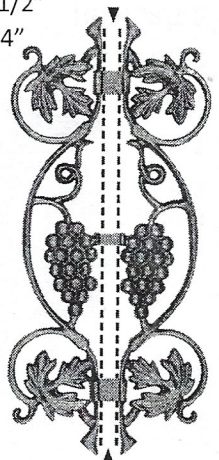

SIZE
1/2"

#47

SINGLE FACED
HEIGHT 16 1/2"
WIDTH 6 3/4"

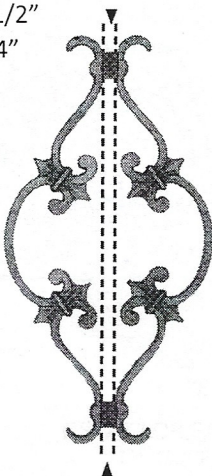

SIZE
1/2"

#48

SINGLE FACED
HEIGHT 16 1/2"
WIDTH 6 3/4"

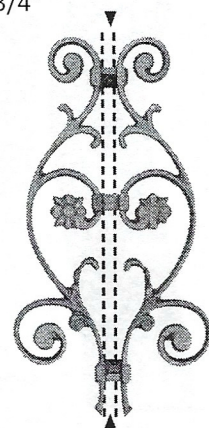

SIZE
1/2"

#49

SINGLE FACED
HEIGHT 16 1/2"
WIDTH 6 3/4"

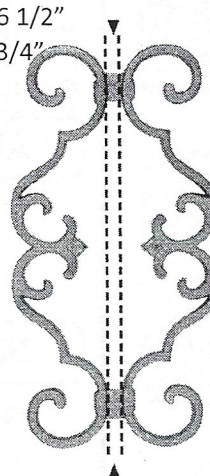

SIZE
1/2"

#50

SINGLE FACED
HEIGHT 16 1/2"
WIDTH 6 3/4"

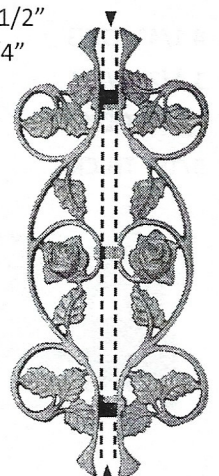

SIZE
1/2"

ALUMINUM PICKET CASTINGS

#36

DOUBLE FACED
HEIGHT 18"
WIDTH 3 1/2"

VALANCE

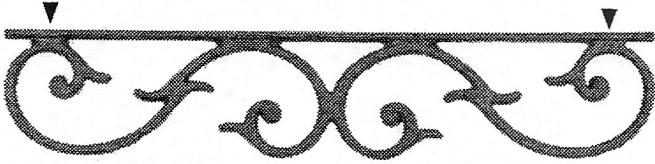

#51

SINGLE FACED
HEIGHT 3 7/8"
WIDTH 3 7/8"

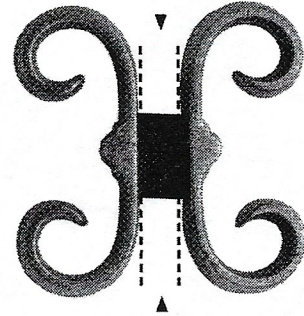

#52

DOUBLE FACED
HEIGHT 5 1/4"
LENGTH 30 1/2"



#53

DOUBLE FACED
HEIGHT 30"
WIDTH 7 3/4"

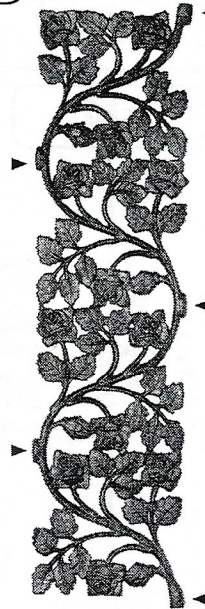

#54

CORNER
BRACKET

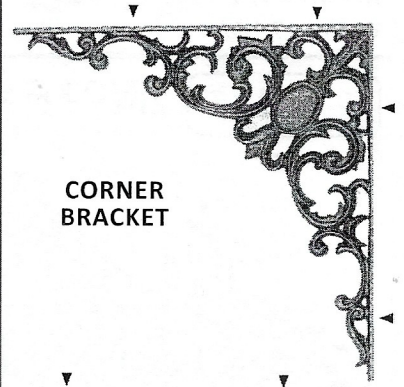

DOUBLE FACED
HEIGHT 15"
WIDTH 15"

#55

SINGLE FACED
HEIGHT 23 1/8"
WIDTH 9"

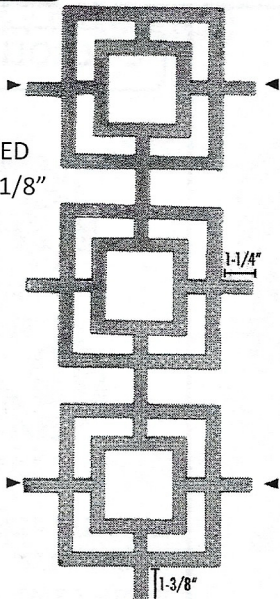

#56

CORNER
BRACKET

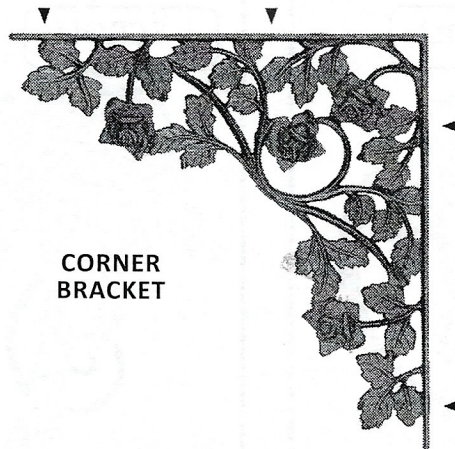

DOUBLE FACED
HEIGHT 14 7/8"
WIDTH 14 7/8"

#57

DOUBLE FACED
HEIGHT 2 1/2"
WIDTH 18 1/4"

VALANCE



ALUMINUM PICKET CASTINGS

#58

CORNER BRACKET

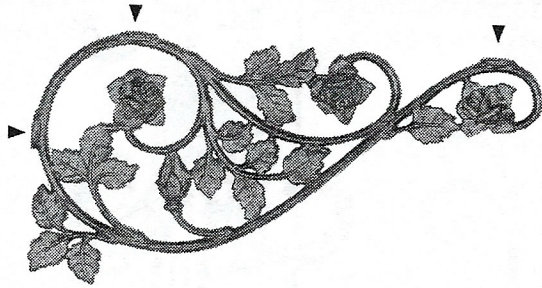

DOUBLE FACED
HEIGHT 8 7/8"
WIDTH 17 1/2"

#59

ZIA

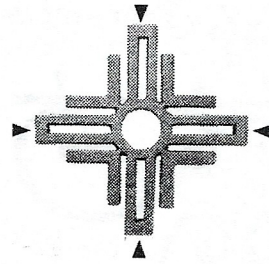

SINGLE FACED
HEIGHT 10"
WIDTH 10"
THICKNESS 5/8"

#60

ZIA

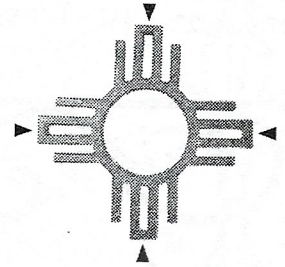

SINGLE FACED
HEIGHT 11 3/8"
WIDTH 11 3/8"
THICKNESS 5/8"

#61

ZIA

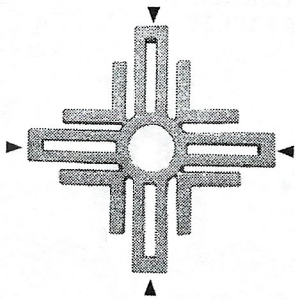

SINGLE FACED
HEIGHT 17 7/8"
WIDTH 17 7/8"
THICKNESS 5/8"

#62

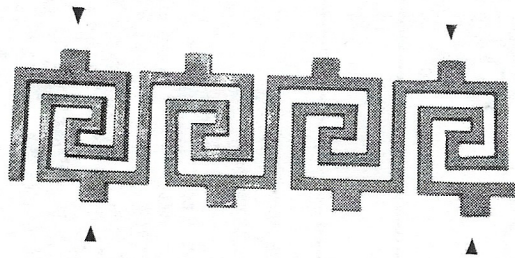

SINGLE FACED
HEIGHT 4 1/8"
WIDTH 13 1/2"

#63

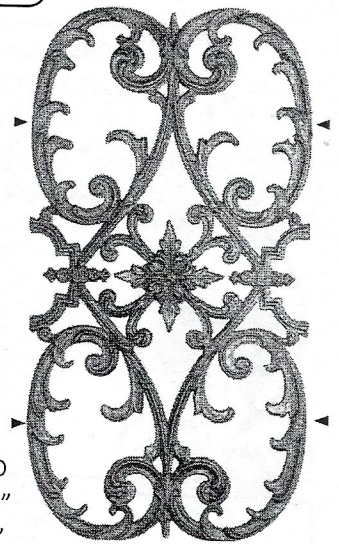

DOUBLE FACED
HEIGHT 26 1/8"
WIDTH 13 5/8"

C-SCROLL

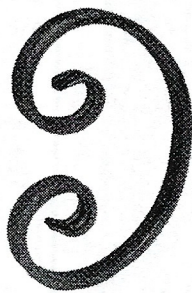

1/2" X 1/4"
HEIGHT 5 1/2"
WIDTH 3 3/4"

S-SCROLL



1/2" X 1/4"
HEIGHT 10 5/8"
WIDTH 4 5/16"

C-SCROLL

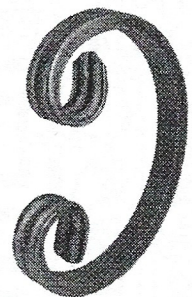

1/2" X 1/4" (12mm x 6mm)
HEIGHT 5 1/2"
WIDTH 3 3/4"

SINGLE FACED
HEIGHT 13 1/2"
WIDTH 6 1/4"

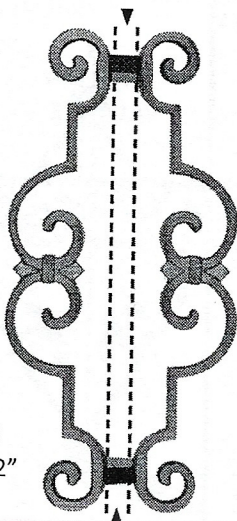

ALUMINUM PICKET CASTINGS

LIONS OF ELIZABETH

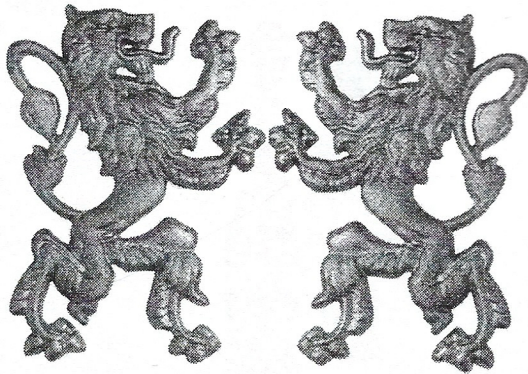

SINGLE FACED
HEIGHT 10 3/8"
WIDTH 6 7/8"

Screw Hole On Back For Hanging

BRITANNIC LIONS

Weld Tabs On Top & Bottom

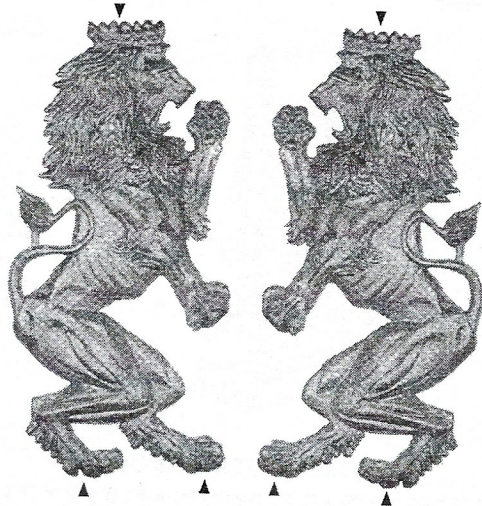

SINGLE FACED
HEIGHT 32"
WIDTH 14"

BRONC RIDER

SINGLE FACED
HEIGHT 17"
WIDTH 12"

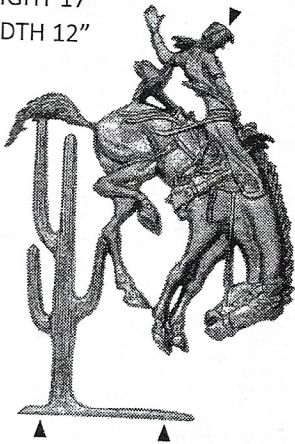

MARE DI MORGAN

SINGLE FACED
HEIGHT 19"
WIDTH 36"

2 Flat Knuckles On Back That
Can Be Drilled For Hanging

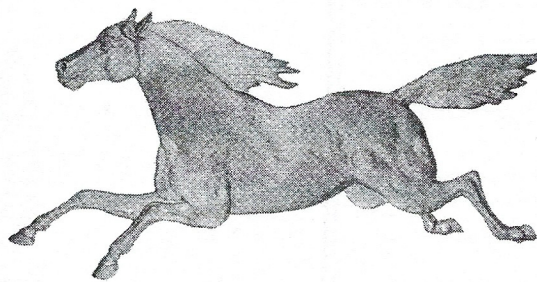

HORSE & COLT

SINGLE FACED
HEIGHT 14"
WIDTH 16 5/8"

Steel Weld Tabs On Sides

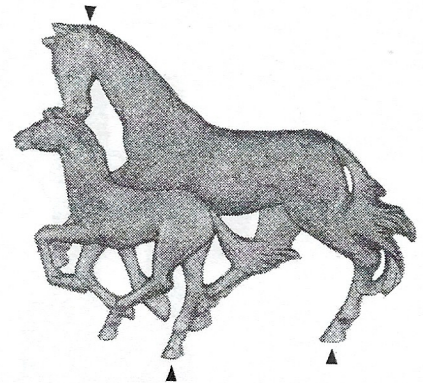

THE RILEY PALMS (LH)

SINGLE FACED
HEIGHT 23"
WIDTH 13 3/4"
THICKNESS 5/8"

SINGLE FACED
HEIGHT 14 7/8"
WIDTH 9 1/2"
THICKNESS 5/8"



THE RILEY PALMS (RH)

SINGLE FACED
HEIGHT 23"
WIDTH 13 3/4"
THICKNESS 5/8"

SINGLE FACED
HEIGHT 14 7/8"
WIDTH 9 1/2"
THICKNESS 5/8"

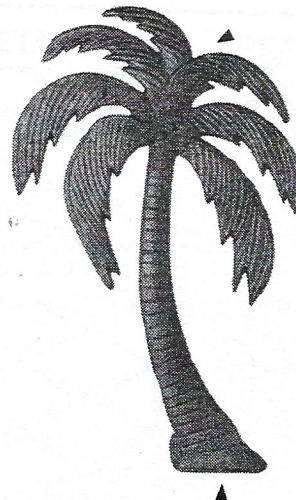

ARROWS DENOTE WELD TABS

CAST IRON SPEARS

#21

PLEASE SPECIFY SIZE



SIZES AVAILABLE TO FIT OVER:
1/2" PICKETS • 5/8" PICKETS • 3/4" PICKETS

#22

PLEASE SPECIFY SIZE



SIZES AVAILABLE TO FIT OVER:
1/2" PICKETS • 5/8" PICKETS • 3/4" PICKETS • 1" PICKETS

#23

PLEASE SPECIFY SIZE

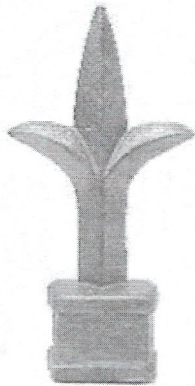

SIZES AVAILABLE TO FIT OVER:
1/2" PICKETS • 5/8" PICKETS • 3/4" PICKETS • 1" PICKETS

#24

PLEASE SPECIFY SIZE



SIZES AVAILABLE TO FIT OVER:
1/2" PICKETS • 5/8" PICKETS • 3/4" PICKETS

#25

PLEASE SPECIFY SIZE



SIZES AVAILABLE TO FIT OVER:
1/2" PICKETS • 5/8" PICKETS • 3/4" PICKETS

#26

PLEASE SPECIFY SIZE

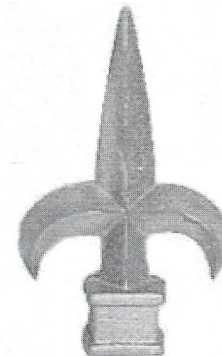

SIZES AVAILABLE TO FIT OVER:
1/2" PICKETS • 5/8" PICKETS • 3/4" PICKETS

PLASTIC SPEARS

#25

BLACK

PLEASE SPECIFY SIZE

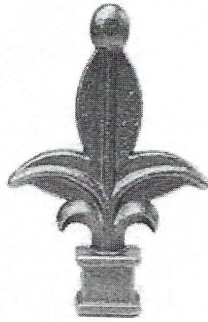

SIZES AVAILABLE TO FIT OVER:
1/2" PICKETS • 5/8" PICKETS • 3/4" PICKETS • 1" PICKETS

#27

BLACK

PLEASE SPECIFY SIZE

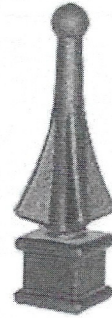

SIZES AVAILABLE TO FIT OVER:
1/2" PICKETS • 5/8" PICKETS • 3/4" PICKETS

#28

WHITE

PLEASE SPECIFY SIZE



SIZES AVAILABLE TO FIT OVER:
1/2" PICKETS • 5/8" PICKETS • 3/4" PICKETS

#29

BLACK

PLEASE SPECIFY SIZE



SIZES AVAILABLE TO FIT OVER:
1/2" PICKETS • 5/8" PICKETS • 3/4" PICKETS

#30

WHITE



SCREEN & SHEET METAL

SHEET METAL

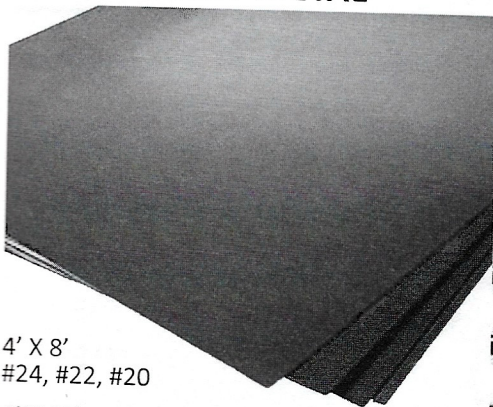

4' X 8'
#24, #22, #20

4' X 10'
#24

EXPANDED METAL

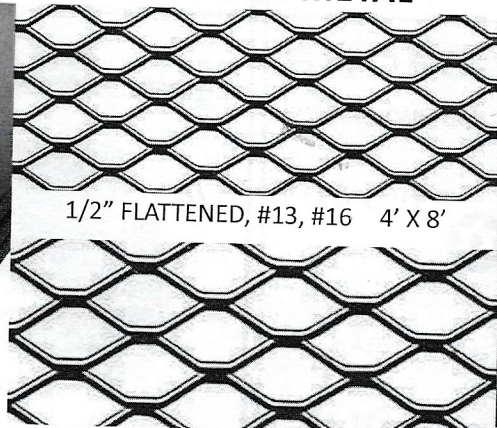

1/2" FLATTENED, #13, #16 4' X 8'

3/4" FLATTENED, #9 4' X 8'

PERFORATED METAL

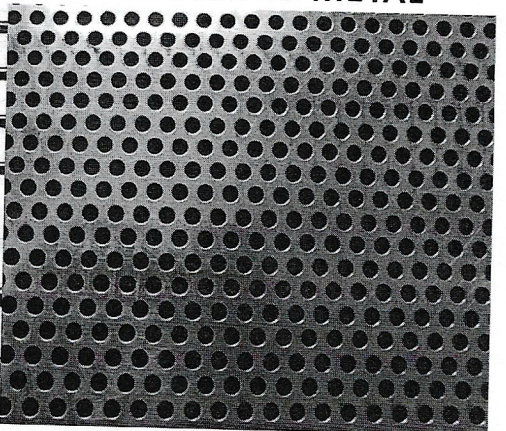

1/16" DIA. HOLE 3' X 7' • 4' X 7' • 4' X 8'

SCREWS, SHIELDS & ANCHORS

ONE WAY SCREWS

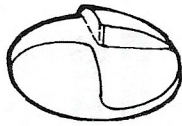

1/4"

1 1/2"

2"

3"

5/16"

2"

3"

4"

- BLACK OXIDE
- HEAT TREATED
- TRUSS HEAD
- THREADED FULL LENGTH

POWER BITS

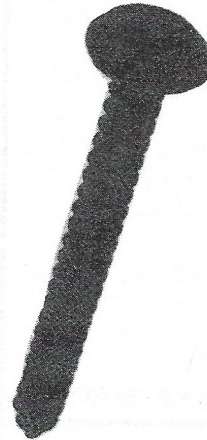
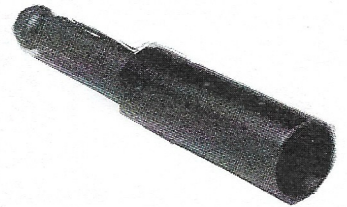

1/4" SCREWS, 1/4" SHANK

5/16" SCREWS, 7/16" SHANK

TORX HEAD SCREWS

- THREADED FULL LENGTH

1/4"

1 1/2"

2"

3"

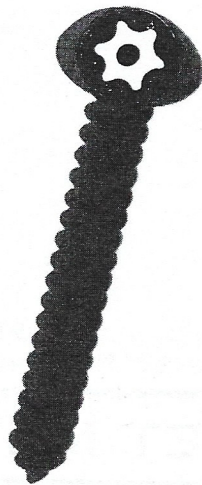

LAG SHIELDS

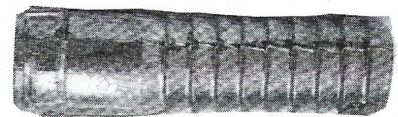

1/4" LONG

5/16" LONG

POWER BITS



1/4" SHANK

NAIL IN ANCHORS

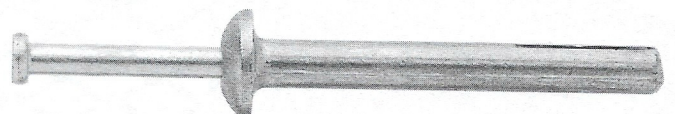

1/4"

1 1/4"

1 1/2"

2"

MISCELLANEOUS

NEWEL POST BALLS



SQUARE	1 1/2"	3"
1"	2"	4"
1 1/4"	2 1/2"	6"

NEWEL POST CAP



SQUARE	1 1/2"	4"
1"	2"	6"
1 1/4"	3"	

RINGS MADE OF 1/2" TUBING

- 3 1/2"
- 4"
- 4 1/2"
- 5"
- 6"
- 8"
- 10"

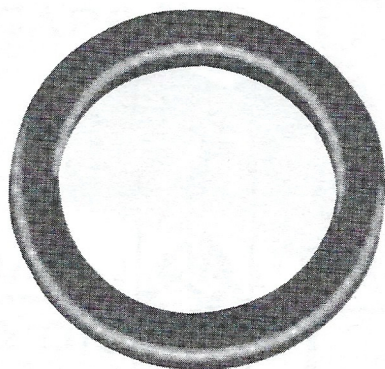

PRESSED METAL POST CAPS

- 1"
- 1 1/4"
- 1 1/2"
- 2"
- 2 1/2"
- 3"
- 4"

SQUARE

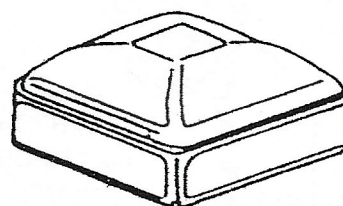

CAPS FIT TIGHT,
NO WELDING NECESSARY

BALUSTER COLLARS FITS OVER PICKETS

#20

- 1/2"
- 5/8"
- 3/4"
- 1"



SHOES

SQUARE TWO EAR

FITS OVER

- 1"
- 1 1/4"
- 1 1/2"

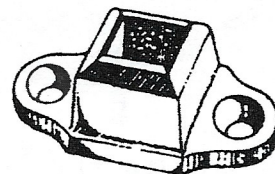

ARTISTIC FORGED STEEL BASKETS

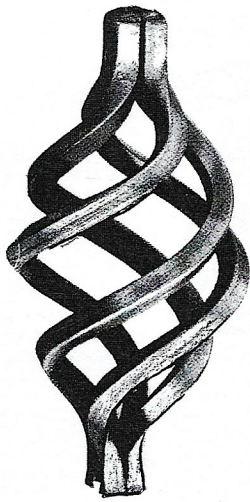

1" SQ.



3/4" SQ.



5/8" SQ.



1/2" SQ.

FORGED STEEL BALLUSTERS

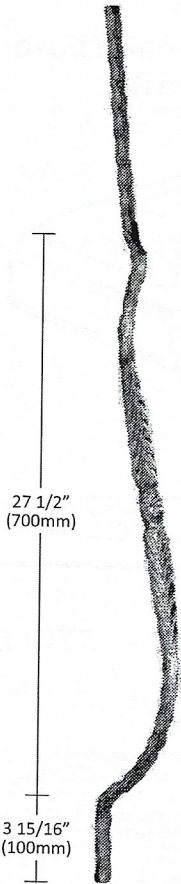

9/16" (14mm)
HEIGHT 39 3/8"
DEPTH 5 1/8"

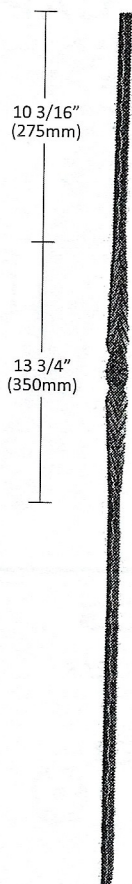

9/16" (14mm)
HEIGHT 45 1/4"
DEPTH 1 1/4"



1/2" (12mm)
HEIGHT 45 1/4"
DEPTH 2 1/2"

ROMAN
COLLAR

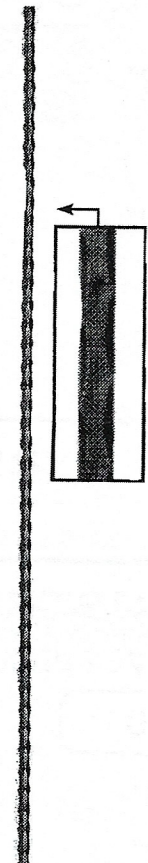

1/2" (12mm)
HEIGHT 45 1/4"

MISCELLANEOUS

GATE SPRING ROLLERS

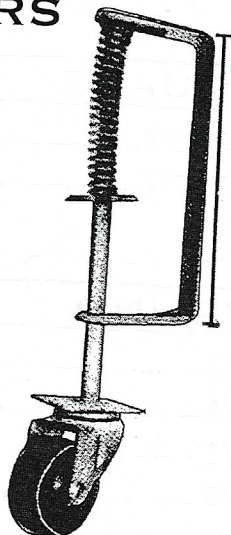

90° WELDABLE ELBOWS

- 1 1/4" I.D. PIPE
- 1 1/2" I.D. PIPE

- WELDABLE STEEL
- SCHEDULE 40
- BLACK FINISH
- BEVELED EDGES

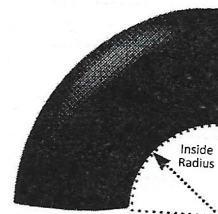

BEVELED PIPE END CAPS

- 1 1/4" I.D. PIPE
- 1 1/2" I.D. PIPE

- WELDABLE STEEL
- SCHEDULE 40
- BLACK FINISH
- BEVELED EDGES



WELDABLE SPRING CLOSERS

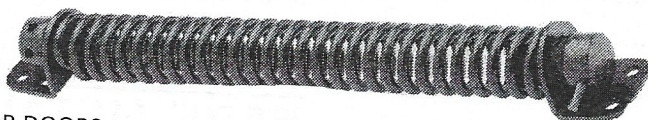

- FOR GATES OR DOORS
- BLACK WITH HEAVY DUTY SCREWS
- ADJUSTABLE

AVAILABLE IN: 9" & 12"

HANDRAIL BRACKET

FOR FLAT MATERIAL

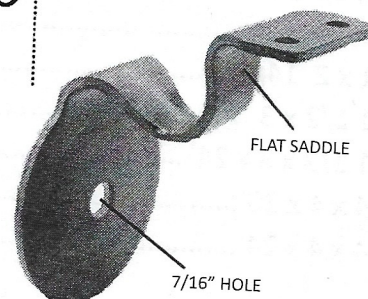
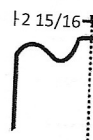

HEIGHT 3 7/8"
DEPTH 2 3/4"

(EXTENDS 2 15/16" FROM WALL TO SADDLE CENTERLINE)

PLASTIC CAPS



AVAILABLE IN: 1/2", 5/8", 3/4", 1", 1 1/4", 1 1/2", 2" & 1"X2"

WHEELS & DISCS

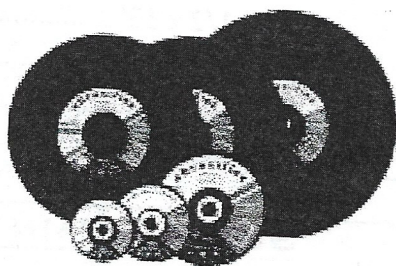

4 1/2" GRINDING WHEEL & FLAP DISC
4 1/2" & 14" CUTTING WHEELS

PAINT

PAINT:
BLACK
WHITE
PRIMER (GRAY)
1 GAL. THINNER

SPRAY CANS:
BLACK
WHITE
PRIMER (GRAY)

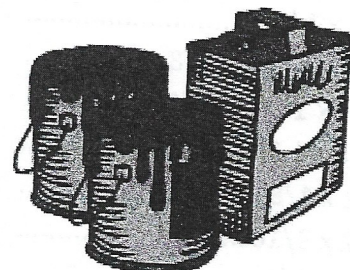

OTHER PAINT COLORS UPON REQUEST

SQ. TUBING

1/2 x 1/2 x 20'
1/2 x 1/2 x 24'
5/8 x 5/8
3/4 x 3/4
1 x 1
1 x 1 14g
1 x 1 10g
1 1/4 x 1 1/4
1 1/4 x 1 1/4 14g
1 1/4 x 1 1/4 10g
1 1/2 x 1 1/2
1 1/2 x 1 1/2 14g
1 x 3 14g
2 x 2
2 x 2 14g
2 1/2 x 2 1/2 10g
3 x 3
3 x 3 x 24'
1/2 x 1
1 x 2
1 x 2 14g
1 1/2 x 3 14g
1 1/2 x 3 x 24'
4 x 4 x 20'
4 x 4 x 24'

ANGULO/ANGLE

1/2 x 1/2 x 1/8
3/4 x 3/4 x 1/8
1 x 1 x 1/8
1 x 1 x 3/16
1 x 1 x 1/4
1 1/4 x 1 1/4 x 1/8
1 1/4 x 1 1/4 x 3/16
1 1/4 x 1 1/4 x 1/4
2 x 2 x 1/8
2 x 2 x 3/16
2 x 2 x 1/4
3 x 3 x 3/16
3 x 3 x 1/4
4 x 4 x 1/4

SOLERA/FLAT BAR

1/2 x 1/8
1/2 x 3/16
1/2 x 1/4
3/4 x 1/8
3/4 x 3/16
3/4 x 1/4
1 x 1/8
1 x 3/16
1 x 1/4
1 1/4 x 1/8
1 1/4 x 3/16
1 1/4 x 1/4
1 1/2 x 1/8
1 1/2 x 3/16
1 1/2 x 1/4
2 x 1/8
2 x 3/16
2 x 1/4
2 1/2 x 1/8
2 1/2 x 3/16
2 1/2 x 1/4
3 x 1/8
3 x 3/16
3 x 1/4
4 x 1/8
4 x 3/16
4 x 1/4
5 x 1/8
5 x 3/16
5 x 1/4
6 x 1/8
6 x 3/16
6 x 1/4
8 x 1/8

HANDRAIL

1 15/16
Tubular
1 5/8
1 3/4 19f
Handrail End

TWIST

1/2
5/8

SQUARE

3/8 x 3/8
1/2 x 1/2

ROUND

3/6
1/4
5/16
3/8
1/2
5/8
3/4

PERF. METAL

3' x 7'
4' x 7'
4' x 8'

EX. METAL

1/2 - 4' x 8' - 16g
1/2 - 4' x 8' - 13g
3/4 - 4' x 8' - 9g

HAMMERED TUBE

1/2 x 1/2 x 19'
3/4 x 3/4 x 19'
1 x 1 x 19'

SHEET (PAINT LOCK)

24g - 4' x 8'
24g - 4' x 10'
22g - 4' x 8'
20g - 4' x 8'